

Ordering Information

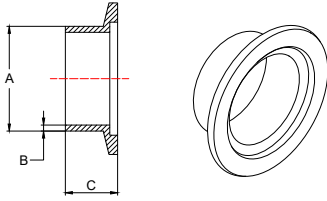

- Stainless Steel Type 304
- Buttweld
- Standard Inch Stub Diameters

Flange, Short Weld Stub, Stainless Steel

in./(mm)

Flange Size (ISO)	For Tubing OD	A	B	C	Part Number
NW 10	1/2"	0.50 (13)	0.065 (1.7)	0.50 (13)	100310300
NW 16	1/2"	0.50 (13)	0.065 (1.7)	0.50 (13)	100310301
NW 16	3/4"	0.75 (19)	0.065 (1.7)	0.50 (13)	100310311
NW 25	1"	1.00 (25)	0.065 (1.7)	0.50 (13)	100310303
NW 40	1 1/2"	1.50 (38)	0.065 (1.7)	0.75 (19)	100310305
NW 50	2"	2.00 (51)	0.065 (1.7)	0.75 (19)	100310306

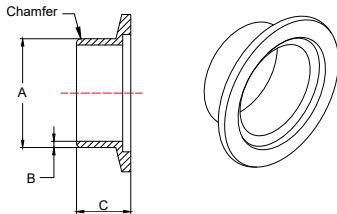

- Aluminum Type 6061T6
- Buttweld
- Standard Inch Stub Diameters

Flange, Short Weld Stub, Aluminum

in./(mm)

Flange Size (ISO)	For Tubing OD	A	B	C	Part Number
NW 16	1/2"	0.50 (13)	0.065 (1.7)	0.50 (13)	100310101
NW 16	3/4"	0.75 (19)	0.065 (1.7)	0.50 (13)	100310111
NW 25	1"	1.00 (25)	0.065 (1.7)	0.50 (13)	100310103
NW 40	1 1/2"	1.50 (38)	0.083 (2.1)	0.75 (19)	100310105
NW 50	2"	2.00 (51)	0.083 (2.1)	0.75 (19)	100310106

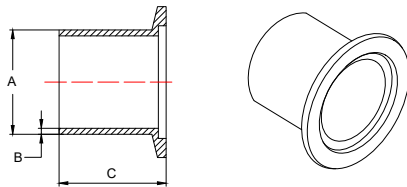

- Stainless Steel Type 304
- Buttweld
- Standard Inch Stub Diameters

Flange, Long Weld Stub, Stainless Steel

in./(mm)

Flange Size (ISO)	For Tubing OD	A	B	C	Part Number
NW 10	1/2"	0.50 (13)	0.065 (1.7)	1.58 (40)	100315700
NW 16	1/2"	0.50 (13)	0.065 (1.7)	1.58 (40)	100315701
NW 16	3/4"	0.75 (19)	0.065 (1.7)	1.58 (40)	100315711
NW 25	1"	1.00 (25)	0.065 (1.7)	1.58 (40)	100315703
NW 40	1 1/2"	1.50 (38)	0.065 (1.7)	1.58 (40)	100315705
NW 50	2"	2.00 (51)	0.065 (1.7)	1.58 (40)	100315706

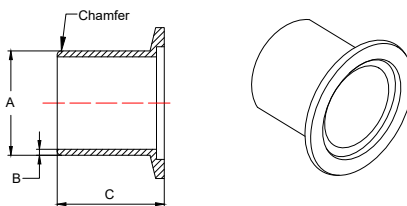

- Aluminum Type 6061T6
- Standard Inch Stub Diameters

Flange, Long Weld Stub, Aluminum

in./(mm)

Flange Size (ISO)	For Tubing OD	A	B	C	Part Number
NW 16	1/2"	0.50 (13)	0.065 (1.7)	1.58 (40)	100310201
NW 16	3/4"	0.75 (19)	0.065 (1.7)	1.58 (40)	100310211
NW 25	1"	1.00 (25)	0.065 (1.7)	1.58 (40)	100310203
NW 40	1 1/2"	1.50 (38)	0.083 (2.1)	1.58 (40)	100310205
NW 50	2"	2.00 (51)	0.083 (2.1)	1.58 (40)	100310206

Flange, Weld Socket, Stainless Steel

in./ (mm)

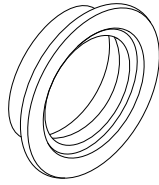
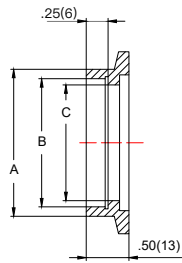

- Stainless Steel Type 304
- Self Aligning
- Standard Tube Weld Prep.
- Also Suitable for Buttweld

Flange Size (ISO)	For Tubing OD	A	B	C	Part Number
NW 16	1/2"	0.61 (15)	0.51 (13)	0.45 (11)	100318301
NW 16	5/8"	0.77 (20)	0.64 (16)	0.58 (15)	100318311
NW 16	3/4"	0.87 (22)	0.76 (19)	0.68 (17)	100318321
NW 25	1"	1.13 (29)	1.02 (26)	0.87 (22)	100318303
NW 40	1 1/2"	1.75 (44)	1.50 (38)	1.37 (35)	100318305
NW 50	2"	2.25 (57)	2.02 (51)	1.87 (47)	100318306

Flange, Blank with Bore, Stainless Steel

in./ (mm)

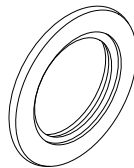
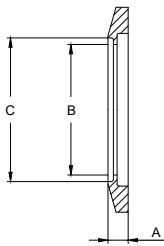

- Stainless Steel Type 304
- Standard Inch Tube OD's

Flange Size (ISO)	For Tubing OD	A	B	C	Part Number
NW 10	1/4"	0.20 (5)	0.26 (7)	N/A	100319710
NW 10	3/8"	0.20 (5)	0.39 (10)	N/A	100319720
NW 10	1/2"	0.20 (5)	0.44 (11)	0.51 (13)	100319700
NW 16	1/4"	0.20 (5)	0.26 (7)	N/A	100319711
NW 16	3/8"	0.20 (5)	0.39 (10)	N/A	100319721
NW 16	1/2"	0.20 (5)	0.51 (13)	N/A	100319731
NW 16	3/4"	0.20 (5)	0.68 (17)	0.76 (19)	100319701
NW 25	1/4"	0.20 (5)	0.26 (7)	N/A	100319713
NW 25	3/8"	0.20 (5)	0.39 (10)	N/A	100319723
NW 25	1/2"	0.20 (5)	0.51 (13)	N/A	100319733
NW 25	3/4"	0.20 (5)	0.63 (16)	0.76 (19)	100319743
NW 25	1"	0.20 (5)	0.89 (23)	1.02 (26)	100319703
NW 40	1/4"	0.20 (5)	0.26 (7)	N/A	100319715
NW 40	3/8"	0.20 (5)	0.39 (10)	N/A	100319725
NW 40	1/2"	0.20 (5)	0.51 (13)	N/A	100319735
NW 40	3/4"	0.20 (5)	0.63 (16)	0.76 (19)	100319745
NW 40	1"	0.20 (5)	0.89 (23)	1.02 (26)	100319755
NW 40	1 1/2"	0.20 (5)	1.39 (35)	1.52 (39)	100319705
NW 50	1/4"	0.20 (5)	0.26 (7)	N/A	100319716
NW 50	3/8"	0.20 (5)	0.39 (10)	N/A	100319726
NW 50	1/2"	0.20 (5)	0.51 (13)	N/A	100319736
NW 50	3/4"	0.20 (5)	0.63 (16)	0.76 (19)	100319746
NW 50	1"	0.20 (5)	0.89 (23)	1.02 (26)	100319756
NW 50	1 1/2"	0.20 (5)	1.39 (35)	1.52 (39)	100319766
NW 50	2"	0.20 (5)	1.89 (48)	2.02 (51)	100319706

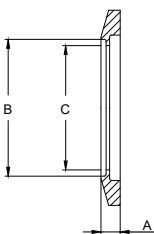

- Stainless Steel Type 304

Flange, Blank with Bore, KF 80 / KF 100, Stainless Steel

in./ (mm)

Flange Size (ISO)	For Tubing OD	A	B	C	Part Number
NW 80	3"	0.47 (12)	3.02 (76)	2.90 (74)	100319801
NW 100	4"	0.47 (12)	4.02 (102)	3.87 (98)	100319803

Flange, Blank-Off, Stainless Steel

in./(mm)

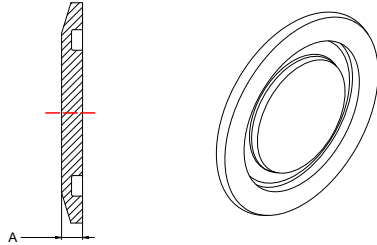

- Stainless Steel Type 304
- To Close Off Unused Ports

Flange Size (ISO)	A	Part Number
NW 10	0.20 (5)	100311700
NW 16	0.20 (5)	100311701
NW 25	0.20 (5)	100311703
NW 40	0.20 (5)	100311705
NW 50	0.20 (5)	100311706
NW 80	0.43 (11)	100319802
NW 100	0.43 (11)	100319804

Flange, Blank-Off, Aluminum

in./(mm)

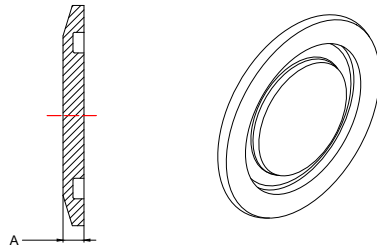

- Aluminum Alloy
- To Close Off Unused Ports

Flange Size (ISO)	A	Part Number
NW 10	0.20 (5)	100311600
NW 16	0.20 (5)	100311601
NW 25	0.20 (5)	100311603
NW 40	0.20 (5)	100311605
NW 50	0.20 (5)	100311606

Flange, Unbored Stub, Stainless Steel

in./(mm)

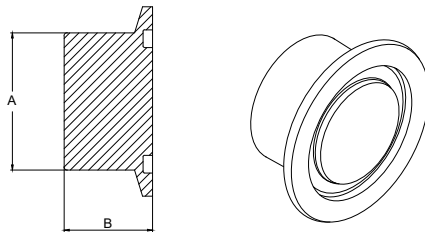

- Stainless Steel Type 304
- Stub may be turned, bored or tapped to fit

Flange Size (ISO)	A	B	Part Number
NW 10	0.75 (19)	0.75 (19)	100311300
NW 16	0.75 (19)	0.75 (19)	100311301
NW 25	1.00 (25)	0.75 (19)	100311303
NW 40	1.50 (38)	1.00 (25)	100311305
NW 50	2.00 (51)	1.00 (25)	100311306

Flange, Unbored Stub, Aluminum

in./(mm)

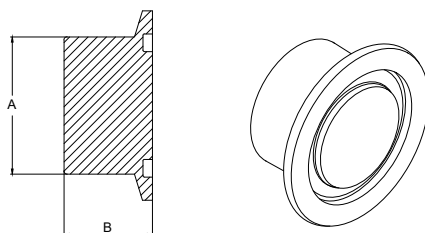

- Aluminum Type 6061T6
- Stub may be turned, bored or tapped to fit

Flange Size (ISO)	A	B	Part Number
NW 10	0.75 (19)	0.75 (19)	100311100
NW 16	0.75 (19)	0.75 (19)	100311101
NW 25	1.00 (25)	0.75 (19)	100311103
NW 40	1.50 (38)	1.00 (25)	100311105
NW 50	2.00 (51)	1.00 (25)	100311106

Seal, Centering Ring Assembly, Stainless Steel/Viton® in./(mm)

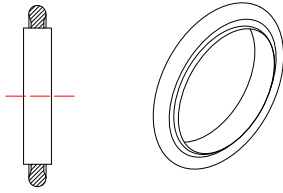

- 180°C Max
- Replaceable O-Ring
- NW 80/100 includes aluminum spacer ring

Flange Size (ISO)	Part Number
NW 10	100312700
NW 16	100312701
NW 25	100312703
NW 40	100312705
NW 50	100312706
NW 80	100760508
NW 100	100760510

Seal, Centering Ring Assembly, Aluminum/Viton® in./(mm)

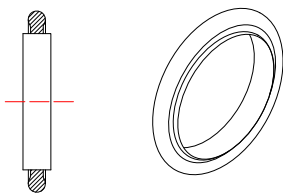

- 180°C Max
- Replaceable O-Ring
- NW 80/100 includes aluminum spacer ring

Flange Size (ISO)	Part Number
NW 10	100312600
NW 16	100312601
NW 25	100312603
NW 40	100312605
NW 50	100312606
NW 80	100760608
NW 100	100760610

Seal, Centering Ring Assembly, Stainless Steel/Buna-N in./(mm)

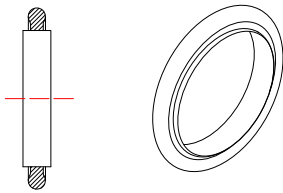

- 80°C Max
- Replaceable O-Ring

Flange Size (ISO)	Part Number
NW 10	100312800
NW 16	100312801
NW 25	100312803
NW 40	100312805
NW 50	100312806

Seal, Centering Ring Assembly, Aluminum/Buna-N in./(mm)

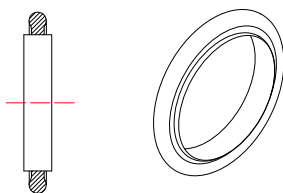

- 80°C Max
- Replaceable O-Ring
- NW 80/100 includes aluminum spacer ring

Flange Size (ISO)	Part Number
NW 10	100312500
NW 16	100312501
NW 25	100312503
NW 40	100312505
NW 50	100312506
NW 80	100760708
NW 100	100760710

Seal, Centering Ring Assembly, Stainless Steel/Silicone in./(mm)

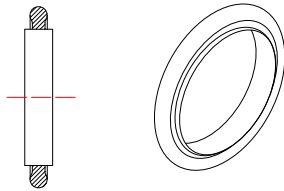

- 200°C Max
- Replaceable O-Ring

Flange Size (ISO)	Part Number
NW 10	100317300
NW 16	100317301
NW 25	100317303
NW 40	100317305
NW 50	100317306

Seal, Centering Ring Assembly Overpressure, Stainless Steel/Viton in./(mm)

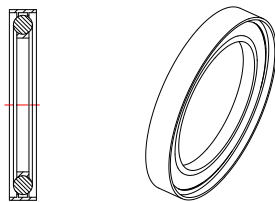

- Stainless Steel Centering Ring
- Replaceable Viton O-Ring
- Includes Aluminum Overpressure Ring

Flange Size (ISO)	Part Number
NW 25	100936525
NW 40	100936524
NW 50	100936523

Seal, Centering Ring Assembly, w/Screen, Stainless Steel/Viton® in./(mm)

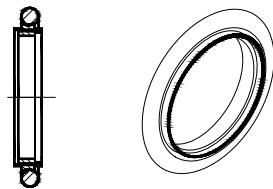

- Stainless Steel Centering Ring
- Replaceable Viton O-Ring
- 72 Mesh Screen Stainless Steel

Flange Size (ISO)	Part Number
NW 16	100318601
NW 25	100318603
NW 40	100318605
NW 50	100318606

Seal, Adaptive Centering Ring Assembly, Stainless Steel/Viton in./(mm)

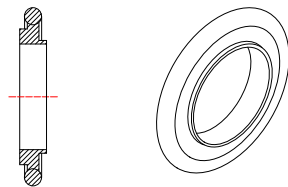

- Stainless Steel Centering Ring
- Replaceable Viton O-Ring
- For Obsolete Bore Sizes

Flange Size (ISO)	Flange Size (ISO)	Part Number
NW 16	NW 10	100315821
NW 25	NW 20	100315823
NW 40	NW 32	100315825

Seal, Adaptive Centering Ring Assembly, Aluminum/Viton in./(mm)

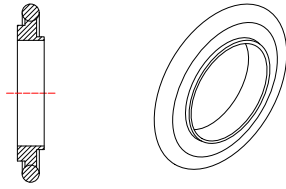

- Replaceable Viton O-Ring
- For Obsolete Bore Sizes

Flange Size (ISO)	Flange Size (ISO)	Part Number
NW 16	NW 10	100315811
NW 25	NW 20	100315813
NW 40	NW 32	100315815

Seal, Adaptive Centering Ring Assembly, Aluminum/Buna-N in./(mm)

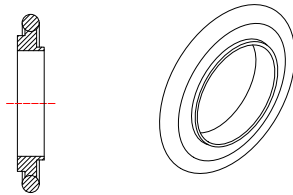

- Replaceable O-Ring
- For Obsolete Bore Sizes

Flange Size (ISO)	Flange Size (ISO)	Part Number
NW 16	NW 10	100315801
NW 25	NW 20	100315803
NW 40	NW 32	100315805

Seal, Replacement O-Ring, Viton® in./(mm)

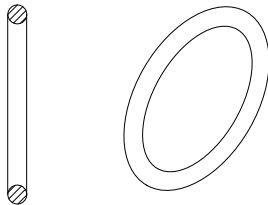

- Standard Inch O-Ring Sizes

Flange Size (ISO)	Standard O-Ring Size	Part Number
NW 10	2-312	100314000
NW 16	2-314	100314001
NW 25	2-320	100314003
NW 40	2-326	100314005
NW 50	2-330	100314006
NW 80	2-340	100762008
NW 100	2-346	100762010

Seal, Replacement O-Ring, Buna-N in./(mm)

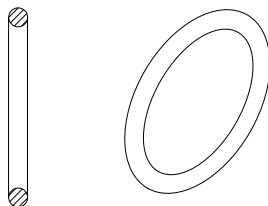

- Standard Inch O-Ring Sizes

Flange Size (ISO)	Standard O-Ring Size	Part Number
NW 10	2-312	100313900
NW 16	2-314	100313901
NW 25	2-320	100313903
NW 40	2-326	100313905
NW 50	2-330	100313906
NW 80	2-340	100761908
NW 100	2-346	100761910

Seal, Replacement O-Ring, Silicone

in./(mm)

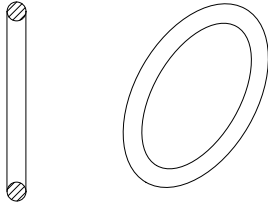

- Standard Inch O-Ring Sizes

Flange Size (ISO)	Standard O-Ring Size	Part Number
NW 10	2-312	100317310
NW 16	2-314	100317311
NW 25	2-320	100317313
NW 40	2-326	100317315
NW 50	2-330	100317316

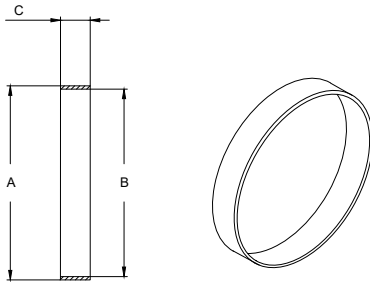

- Stainless Steel
- Fits over OD of O-ring
- Use to retain O-ring when system is used at internal pressures over atmospheric

Ring, Overpressure

in./(mm)

Flange Size (ISO)	Max. Pressure	A	B	C	Part Number
NW 16	100 psig	1.25 (31)	1.19 (30)	0.35 (9)	100316301
NW 25	100 psig	1.66 (42)	1.58 (40)	0.35 (9)	100316303
NW 40	75 psig	2.25 (57)	2.17 (55)	0.35 (9)	100316305
NW 50	50 psig	2.75 (70)	2.66 (68)	0.14 (4)	100316306

Clamp, Toggle

in./(mm)

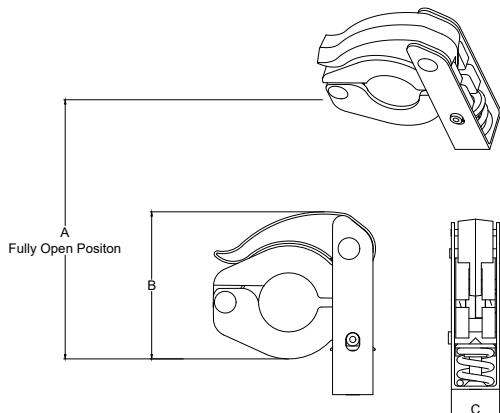

- Aluminum
- Quick Operating
- Positive Locking Method
- Self Adjusting
- Cannot Be Over-tightened

Flange Size (ISO)	Fits Sizes	A	B	C	Part Number
NW 16	16/10	4.05 (103)	2.50 (64)	0.75 (19)	100318801
NW 25	25/20	4.31 (109)	2.96 (75)	0.75 (19)	100318803
NW 40	40/32	4.87 (124)	3.29 (84)	0.75 (19)	100318805
NW 50	50	6.34 (161)	4.73 (120)	0.89 (23)	100318806

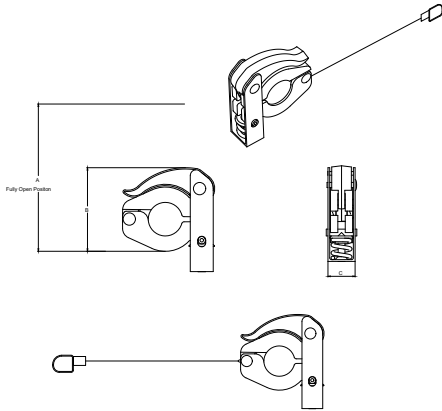

Clamp, Toggle w/Lanyard

in./(mm)

Flange Size (ISO)	Fits Sizes	A	B	C	Part Number
NW 16	16/10	4.05 (103)	2.50 (64)	0.75 (19)	100318801-L
NW 25	25/20	4.31 (109)	2.96 (75)	0.75 (19)	100318803-L
NW 40	40/32	4.87 (124)	3.29 (84)	0.75 (19)	100318805-L
NW 50	50	6.34 (161)	4.73 (120)	0.89 (23)	100318806-L

- Aluminum
- Fastening pin on lanyard prevents accidental opening and pin loss
- Positive locking method
- Self-adjusting
- Heavy duty spring supports the full range of production tolerance variables

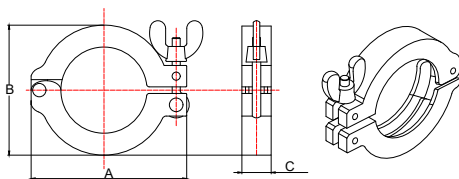

Clamp, Wing Nut

in./(mm)

Flange Size (ISO)	Fits Sizes	A	B	C	Part Number
NW 16	16/10	2.24 (57)	1.69 (43)	0.63 (16)	100312901
NW 25	25/20	2.76 (70)	2.17 (55)	0.63 (16)	100312903
NW 40	40/32	3.39 (86)	2.76 (70)	0.63 (16)	100312905
NW 50	50	4.33 (110)	3.70 (94)	0.79 (20)	100312906

- Aluminum
- 70 inch-pounds max torque

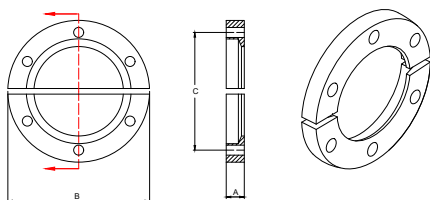

Clamp, Bulkhead

in./(mm)

Flange Size (ISO)	Number of Bolts	A	B	C	Part Number
NW 16	6	0.36 (9)	2.00 (51)	1.50 (38)	100318901
NW 25	6	0.39 (10)	2.38 (60)	1.89 (48)	100318903
NW 40	6	0.37 (9)	2.94 (75)	2.44 (62)	100318905
NW 50	8	0.40 (10)	3.75 (95)	3.25 (83)	100318906

- Aluminum
- Adapts to a baseplate or fixed flange
- Standard KF seal assembly
- Stainless steel bolts and washers included, 10-32 x 5/8"

- For use with KF 80 and 100 flanges
- Aluminum

Clamp, Chain

in./(mm)

Flange Size (ISO)	Part Number
NW 80	100993460
NW 100	100994717

Conical Reducer, Stainless Steel

in./(mm)

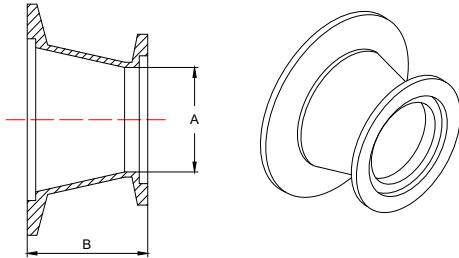

- Mates differing ISO-KF flange sizes

Flange Size (ISO)	Flange Size (ISO)	A	B	Part Number
NW 16	NW 25	0.62 (16)	1.57 (40)	100313711
NW 16	NW 40	0.62 (16)	1.57 (40)	100313712
NW 16	NW 50	0.62 (16)	1.57 (40)	100313713
NW 25	NW 40	0.87 (22)	1.57 (40)	100313714
NW 25	NW 50	0.87 (22)	1.57 (40)	100313715
NW 40	NW 50	1.34 (34)	1.57 (40)	100313716

Conical Reducer, Aluminum

in./(mm)

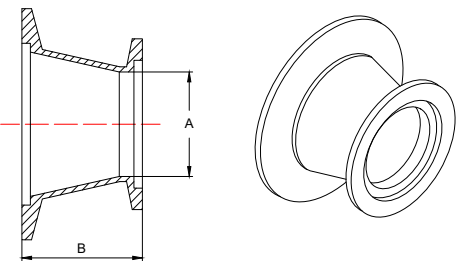

- Mates differing ISO-KF flange sizes

Flange Size (ISO)	Flange Size (ISO)	A	B	Part Number
NW 16	NW 25	0.62 (16)	1.57 (40)	100313511
NW 16	NW 40	0.62 (16)	1.57 (40)	100313512
NW 16	NW 50	0.62 (16)	1.57 (40)	100313513
NW 25	NW 40	0.87 (22)	1.57 (40)	100313514
NW 25	NW 50	0.87 (22)	1.57 (40)	100313515
NW 40	NW 50	1.34 (34)	1.57 (40)	100313516

Conical Adapter, ISO-MF to ISO-KF

in./(mm)

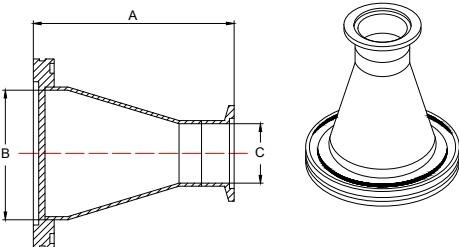

- Stainless Steel Type 304
- High conductance adapter
- Special adapters available upon request

Flange Size (ISO)	A	B	C	Part Number
NW 63 to NW 40	3.39 (86)	2.37 (60)	1.37 (35)	100765006
NW 63 to NW 50	3.39 (86)	2.37 (60)	1.87 (47)	100765017
NW 80 to NW 40	4.64 (118)	2.87 (73)	1.37 (35)	100765016
NW 80 to NW 50	4.64 (118)	2.87 (73)	1.87 (47)	100765008
NW 100 to NW 50	4.64 (118)	3.83 (97)	1.87 (47)	100765018

Step Adapter, ISO-MF to ISO-KF

in./(mm)

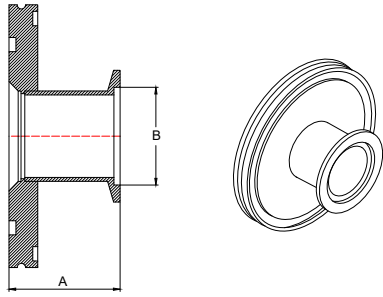

- Stainless Steel Type 304

Flange Size (ISO)	A	B	Part Number
NW 63 to NW 40	1.77 (45)	1.37 (35)	100762606
NW 63 to NW 50	1.77 (45)	1.87 (47)	100762617
NW 80 to NW 40	1.77 (45)	1.87 (47)	100762616
NW 80 to NW 50	1.77 (45)	1.87 (47)	100762608
NW 100 to NW 40	1.77 (45)	1.37 (35)	100762620
NW 100 to NW 50	1.77 (45)	1.87 (47)	100762618

Adapter, ISO-KF to CF

in./(mm)

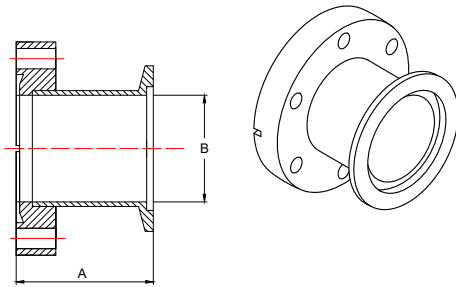

- Stainless Steel Type 304

Flange Size (KF)	Flange Size (CF)	A	B	Part Number
NW 16	Mini 1 1/3"	2.08 (53)	0.62 (16)	100315601
NW 16	2 3/4"	1.78 (45)	0.62 (16)	100315611
NW 25	2 1/8"	1.89 (48)	0.87 (22)	100319812
NW 25	2 3/4"	1.78 (45)	0.87 (22)	100315603
NW 40	2 3/4"	1.78 (45)	1.33 (34)	100315605
NW 50	2 3/4"	2.11 (54)	1.37 (35)	100319813
NW 50	4 1/2"	1.95 (50)	1.83 (46)	100315606

Adapter, ISO-KF to ASA, without O-Ring Groove

in./(mm)

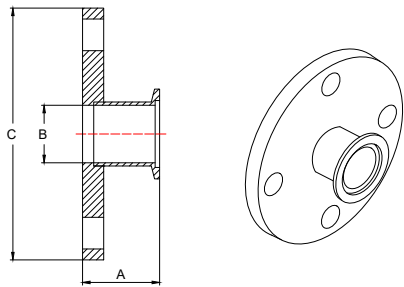

- Stainless Steel Type 304
- Without O-Ring Groove

Flange Size (KF)	Flange Size (ASA)	A	B	C	Part Number
NW 40	1 1/2"	1.81 (46)	1.33 (34)	5.00 (127)	100316755
NW 40	2"	1.81 (46)	1.33 (34)	6.00 (152)	100316705
NW 40	3"	1.81 (46)	1.33 (34)	7.50 (191)	100316715
NW 50	1 1/2"	1.81 (46)	1.83 (46)	5.00 (127)	100316756
NW 50	2"	1.81 (46)	1.83 (46)	6.00 (152)	100316706
NW 50	3"	1.81 (46)	1.83 (46)	7.50 (191)	100316716

Adapter, ISO-KF to ASA, with O-Ring Groove

in./(mm)

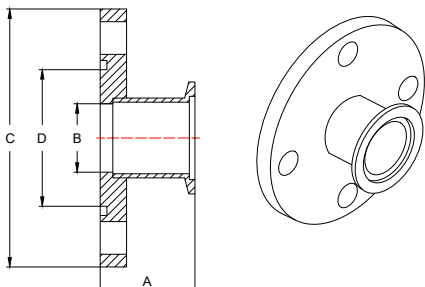

- Stainless Steel Type 304
- With O-ring Groove

Flange Size (KF)	Flange Size (ASA)	Groove ID (O-Ring)	A	B	C	Part Number
NW 40	1 1/2"	2.66" (2-231)	1.81 (46)	1.33 (34)	5.00 (127)	100316775
NW 40	2"	3.42" (2-237)	1.81 (46)	1.33 (34)	6.00 (152)	100316725
NW 40	3"	4.69" (2-247)	1.81 (46)	1.33 (34)	7.50 (191)	100316735
NW 50	1 1/2"	2.66" (2-231)	1.81 (46)	1.83 (46)	5.00 (127)	100316776
NW 50	2"	3.42" (2-237)	1.81 (46)	1.83 (46)	6.00 (152)	100316726
NW 50	3"	4.69" (2-247)	1.81 (46)	1.83 (46)	7.50 (191)	100316736

ASA O-Ring, Viton®

in./(mm)

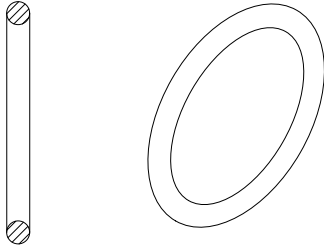

Flange Size (ASA)	O-Ring	Part Number
1 1/2"	2-231	100001380
2"	2-237	100006098
3"	2-247	100006099

Adapter, ISO-KF to NPT-F Pipe, Stainless Steel

in./(mm)

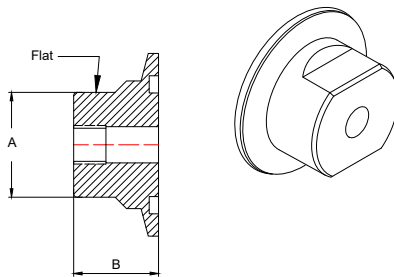

- Teflon Tape recommended to seal
- Compatible with most TC and Pirani tubes

Flange Size (KF)	Flange Size (NPT)	A	B	Part Number
NW 10	1/8"	0.62 (16)	0.75 (19)	100312100
NW 10	1/4"	0.62 (16)	0.75 (19)	100312300
NW 16	1/8"	0.62 (16)	0.75 (19)	100312101
NW 16	1/4"	0.62 (16)	0.75 (19)	100312301
NW 25	1/8"	0.88 (22)	0.75 (19)	100312103
NW 25	1/4"	0.88 (22)	0.75 (19)	100312303
NW 40	1/8"	1.25 (32)	1.00 (25)	100312105
NW 40	1/4"	1.25 (32)	1.00 (25)	100312305
NW 50	1/8"	1.75 (44)	1.00 (25)	100312106
NW 50	1/4"	1.75 (44)	1.00 (25)	100312306

Adapter, ISO-KF to NPT-F Pipe, Aluminum

in./(mm)

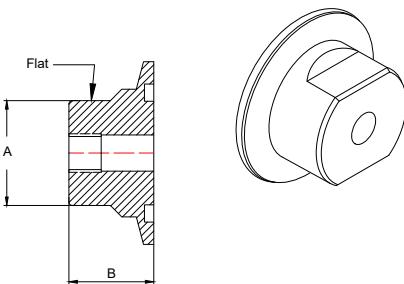

- Teflon Tape recommended to seal
- Compatible with most TC and Pirani tubes

Flange Size (KF)	Flange Size (NPT)	A	B	Part Number
NW 10	1/8"	0.62 (16)	0.75 (19)	100312000
NW 10	1/4"	0.62 (16)	0.75 (19)	100312200
NW 16	1/8"	0.62 (16)	0.75 (19)	100312001
NW 16	1/4"	0.62 (16)	0.75 (19)	100312201
NW 25	1/8"	0.88 (22)	0.75 (19)	100312003
NW 25	1/4"	0.88 (22)	0.75 (19)	100312203
NW 40	1/8"	1.25 (32)	1.00 (25)	100312005
NW 40	1/4"	1.25 (32)	1.00 (25)	100312205
NW 50	1/8"	1.75 (44)	1.00 (25)	100312006
NW 50	1/4"	1.75 (44)	1.00 (25)	100312206

Adapter, ISO-KF to NPT-M Pipe, Stainless Steel in./(mm)

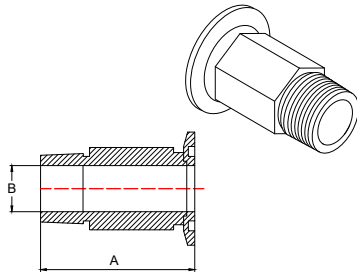

- Stainless Steel
- Hex Shank
- Tapered Thread
- Teflon Tape recommended to seal

Flange Size (KF)	Flange Size (NPT)	A	B	Part Number
NW 16	1/8"	1.57 (40)	0.19 (5)	100316801
NW 16	1/4"	1.97 (50)	0.26 (7)	100316811
NW 25	1/8"	1.57 (40)	0.19 (5)	100316803
NW 25	1/4"	1.97 (50)	0.26 (7)	100316813
NW 25	1/2"	2.95 (75)	0.45 (11)	100316823
NW 25	3/4"	2.95 (75)	0.78 (20)	100316833
NW 40	1/4"	1.97 (50)	0.26 (7)	100316805
NW 40	1/2"	2.95 (75)	0.45 (11)	100316815
NW 40	3/4"	2.95 (75)	0.78 (20)	100316825
NW 40	1"	2.95 (75)	0.88 (22)	100316835
NW 40	1 1/4"	2.00 (51)	1.12 (28)	100316844
NW 40	1 1/2"	2.00 (51)	1.34 (34)	100316845
NW 50	1/4"	1.97 (50)	0.26 (7)	100316806
NW 50	1/2"	2.95 (75)	0.45 (11)	100316816
NW 50	3/4"	2.95 (75)	0.78 (20)	100316826
NW 50	1"	2.95 (75)	0.88 (22)	100316836
NW 50	2"	2.00 (51)	1.87 (47)	100316846

Adapter Tee, ISO-KF to NPT-F Pipe, Stainless Steel in./(mm)

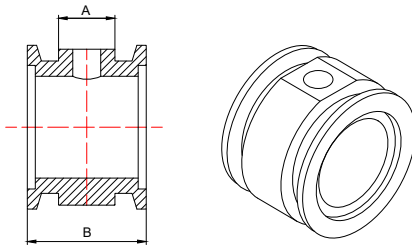

- Available with additional NPT holes
- Teflon Tape recommended to seal

Flange Size (KF)	Flange Size (NPT)	A	B	Part Number
NW 16	1/8" Tapped	0.76 (19)	1.57 (40)	100319401
NW 16	1/4" Tapped	0.76 (19)	1.57 (40)	100319601
NW 25	1/8" Tapped	0.76 (19)	1.57 (40)	100319403
NW 25	1/4" Tapped	0.76 (19)	1.57 (40)	100319603
NW 40	1/8" Tapped	0.76 (19)	1.57 (40)	100319405
NW 40	1/4" Tapped	0.76 (19)	1.57 (40)	100319605
NW 50	1/8" Tapped	0.76 (19)	1.57 (40)	100319406
NW 50	1/4" Tapped	0.76 (19)	1.57 (40)	100319606

Adapter Tee, ISO-KF to NPT-F Pipe, Aluminum in./(mm)

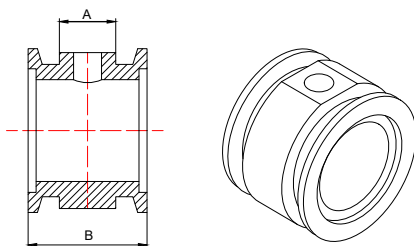

- Available with additional NPT holes
- Teflon Tape recommended to seal

Flange Size (KF)	Flange Size (NPT)	A	B	Part Number
NW 16	1/8" Tapped	0.76 (19)	1.57 (40)	100319301
NW 16	1/4" Tapped	0.76 (19)	1.57 (40)	100319501
NW 25	1/8" Tapped	0.76 (19)	1.57 (40)	100319303
NW 25	1/4" Tapped	0.76 (19)	1.57 (40)	100319503
NW 40	1/8" Tapped	0.76 (19)	1.57 (40)	100319305
NW 40	1/4" Tapped	0.76 (19)	1.57 (40)	100319505
NW 50	1/8" Tapped	0.76 (19)	1.57 (40)	100319306
NW 50	1/4" Tapped	0.76 (19)	1.57 (40)	100319506

Adapter, ISO-KF to Rubber Hose in./(mm)

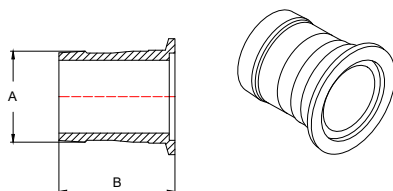

- Aluminum
- Compatible with standard vacuum hose bores

Flange Size (ISO)	Hose Size	A	B	Part Number
NW 16	1/2" or 5/8"	0.63 (16)	1.65 (42)	100311811
NW 16	5/8" or 3/4"	0.75 (19)	1.65 (42)	100311801
NW 25	3/4" or 7/8"	0.88 (22)	1.73 (44)	100311803
NW 40	1 1/2" or 1 5/8"	1.63 (41)	2.17 (55)	100311805
NW 50	1 1/2" or 1 5/8"	1.63 (41)	2.17 (55)	100311806

Adapter, ISO-KF to VCR®-M

in./ (mm)

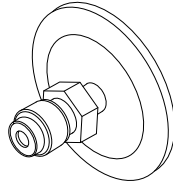
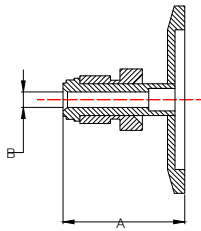

- Stainless Steel

Flange Size (ISO)	Flange Size (VCR)	A	B	VCR Size	Part Number
NW 16	4 VCR	1.40 (36)	0.19 (5)	1/4"	100319111
NW 16	8 VCR	1.63 (41)	0.41 (10)	1/2"	100319121
NW 25	4 VCR	1.40 (36)	0.19 (5)	1/4"	100319113
NW 25	8 VCR	1.60 (41)	0.41 (10)	1/2"	100319123
NW 25	12 VCR	2.14 (54)	0.62 (16)	3/4"	100319133
NW 40	4 VCR	1.40 (36)	0.19 (5)	1/4"	100319115
NW 40	8 VCR	1.60 (41)	0.41 (10)	1/2"	100319125
NW 40	12 VCR	2.10 (53)	0.62 (16)	3/4"	100319135
NW 50	4 VCR	1.40 (36)	0.19 (5)	1/4"	100319116
NW 50	8 VCR	1.60 (41)	0.41 (10)	1/2"	100319126
NW 50	12 VCR	2.10 (53)	0.62 (16)	3/4"	100319136

Adapter, ISO-KF to VCR®-F

in./ (mm)

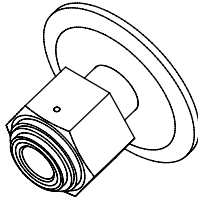
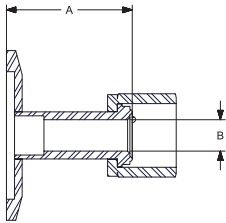

- Stainless Steel

Flange Size (ISO)	Flange Size (VCR)	A	B	VCR Size	Part Number
NW 16	4 VCR	1.40 (36)	0.19 (5)	1/4"	100319211
NW 16	8 VCR	1.63 (41)	0.41 (10)	1/2"	100319221
NW 25	4 VCR	1.40 (36)	0.19 (5)	1/4"	100319213
NW 25	8 VCR	1.60 (41)	0.41 (10)	1/2"	100319223
NW 25	12 VCR	2.14 (54)	0.62 (16)	3/4"	100319233
NW 40	4 VCR	1.40 (36)	0.19 (5)	1/4"	100319215
NW 40	8 VCR	1.60 (41)	0.41 (10)	1/2"	100319225
NW 40	12 VCR	2.10 (53)	0.62 (16)	3/4"	100319235
NW 50	4 VCR	1.40 (36)	0.19 (5)	1/4"	100319216
NW 50	8 VCR	1.60 (41)	0.41 (10)	1/2"	100319226
NW 50	12 VCR	2.10 (53)	0.62 (16)	3/4"	100319236

Adapter, ISO-KF to PVC Hose

in./ (mm)

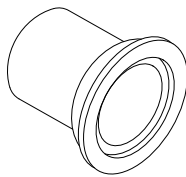
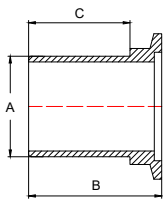

- Stainless Steel Type 304
- Recommend the use of hose clamps

Flange Size (ISO)	Hose Size	A	B	C	Part Number
NW 10	1/2"	0.50 (13)	1.26 (32)	0.79 (20)	100316400
NW 16	1/2"	0.50 (13)	1.26 (32)	0.79 (20)	100316411
NW 16	3/4"	0.75 (19)	1.26 (32)	0.79 (20)	100316401
NW 25	1"	1.00 (25)	1.50 (38)	1.02 (26)	100316403
NW 40	1 1/2"	1.50 (38)	1.97 (50)	1.50 (38)	100316405
NW 50	2"	2.00 (51)	2.17 (55)	1.61 (41)	100316406

Adapter, ISO-KF to Compression Fitting in./(mm)

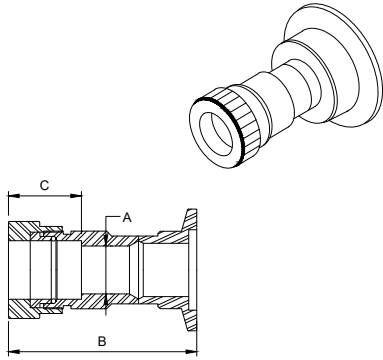

- Stainless Steel
- Viton O-Ring
- Compression fitting tightened by hand
- Compression connect for tube insertion

Flange Size (ISO)	For Tubing OD	A	B	C	Part Number
NW 10	1/2"	0.41 (10)	2.1 (53)	.80 (20)	100316910
NW 16	1/4"	0.19 (5)	1.4 (36)	.62 (16)	100316911
NW 16	1/2"	0.41 (10)	2.4 (61)	.80 (20)	100316921
NW 16	3/4"	0.62 (16)	2.4 (61)	.94 (24)	100316931
NW 25	1/2"	0.41 (10)	2.4 (61)	.80 (20)	100316903
NW 25	3/4"	0.62 (16)	2.5 (64)	.94 (24)	100316913
NW 25	1"	0.88 (22)	2.4 (61)	.94 (24)	100316923
NW 40	1/2"	0.41 (10)	2.6 (66)	.80 (20)	100316905
NW 40	3/4"	0.62 (16)	2.8 (71)	.94 (24)	100316915
NW 40	1"	0.88 (22)	2.8 (71)	.94 (24)	100316925
NW 40	1 1/8"	1.14 (29)	2.9 (74)	.94 (24)	100316945
NW 40	1 1/2"	1.25 (32)	2.9 (74)	.94 (24)	100316935
NW 50	3/4"	0.62 (16)	2.8 (71)	.94 (24)	100316926
NW 50	1"	0.88 (22)	2.8 (71)	.94 (24)	100316936
NW 50	1 1/8"	1.14 (29)	2.9 (74)	.94 (24)	100316946
NW 50	1 1/2"	1.25 (32)	3.0 (76)	.94 (24)	100316906
NW 50	2"	2.01 (51)	3.4 (87)	2.5 (63)	100316916

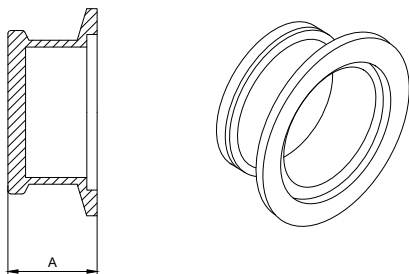

- Stainless Steel Flange
- Max. Temperature 150°C
- Optical quality borosilicate glass

ISO-KF Viewing Port in./(mm)

Flange Size (ISO)	A	Part Number
NW 40	0.93 (24)	100319005
NW 50	1.25 (32)	100319006

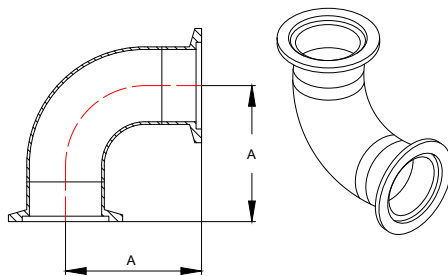

- Stainless Steel Type 304
- Same Size Flanges Both Ports
- Standard Modulus

ISO-KF Elbow 90° Smooth Radius in./(mm)

Flange Size (ISO)	A	Part Number
NW 16	1.57 (40)	100314401
NW 25	1.97 (50)	100314403
NW 40	2.56 (65)	100314505
NW 50	2.76 (70)	100314506

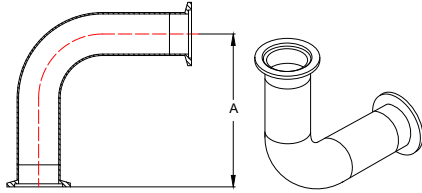

- Stainless Steel Type 304
- Same Size Flanges both Ports
- Twice Standard Modulus

ISO-KF Elbow 90° Smooth, Long Radius in./(mm)

Flange Size (ISO)	A	Part Number
NW 40	5.12 (130)	100314415
NW 50	5.51 (140)	100314416

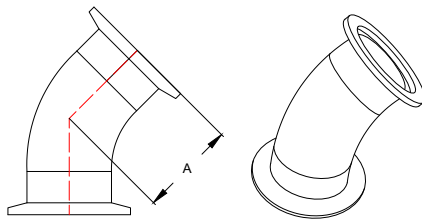

- Stainless Steel Type 304
- Same Size Flanges Both Ports

ISO-KF Elbow 45° Smooth Radius in./(mm)

Flange Size (ISO)	A	Part Number
NW 16	0.91 (23)	100318701
NW 25	1.12 (28)	100318703
NW 40	1.68 (43)	100318705
NW 50	1.99 (51)	100318706

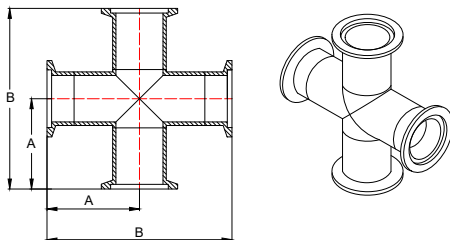

- Stainless Steel Type 304
- Same Size Flanges all Ports
- Standard Modulus

ISO-KF Cross in./(mm)

Flange Size (ISO)	A	B	Part Number
NW 16	1.57 (40)	3.15 (80)	100314801
NW 25	1.97 (50)	3.94 (100)	100314803
NW 40	2.56 (65)	5.12 (130)	100314805
NW 50	2.76 (70)	5.51 (140)	100314806

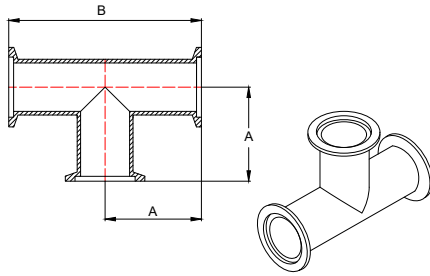

- Stainless Steel Type 304
- Same Size Flanges all Ports
- Standard Modulus

ISO-KF Tee

in./(mm)

Flange Size (ISO)	A	B	Part Number
NW 16	1.57 (40)	3.15 (80)	100314601
NW 25	1.97 (50)	3.94 (100)	100314603
NW 40	2.56 (65)	5.12 (130)	100314605
NW 50	2.76 (70)	5.51 (140)	100314606

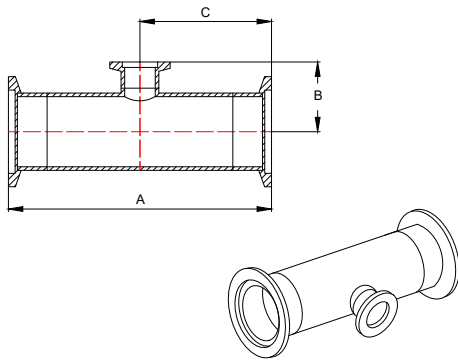

- Stainless Steel Type 304
- Same Size Flanges Thru Ports

ISO-KF Tee, Reducing

in./(mm)

Flange Size (ISO)	Flange Size (ISO) Tee	A	B	C	Part Number
NW 25	NW 16	3.94 (100)	1.08 (27)	1.97 (50)	100318403
NW 40	NW 16	5.12 (130)	1.32 (34)	2.56 (65)	100318405
NW 50	NW 16	5.51 (140)	1.58 (40)	2.76 (70)	100318406
NW 40	NW 25	4.80 (122)	2.40 (61)	2.40 (61)	100319816
NW 50	NW 25	6.29 (160)	2.65 (67)	3.15 (80)	100319815
NW 50	NW 40	6.29 (160)	2.65 (67)	3.15 (80)	100319814

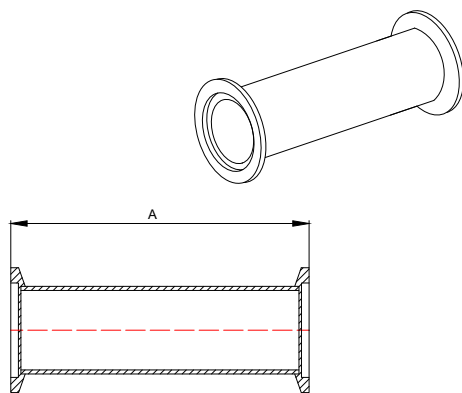

- Stainless Steel Type 304
- Special lengths to order

ISO-KF Straight Section

in./(mm)

Flange Size (ISO)	A	Part Number
NW 16	3.15 (80)	100315101
NW 16	12.60 (320)	100315111
NW 25	3.94 (100)	100315103
NW 25	12.60 (320)	100315113
NW 40	5.12 (130)	100315105
NW 40	12.60 (320)	100315115
NW 50	5.51 (140)	100315106
NW 50	12.60 (320)	100315116

Tubing

in./(mm)

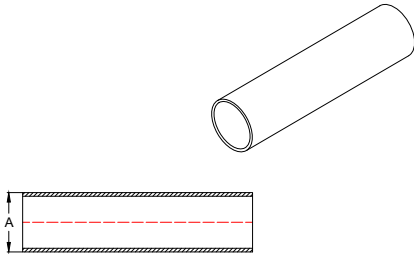

- Tube ends deburred
- Stainless Steel
- Price per 10 foot length of tube

Flange Size (ISO)	A	Tube Wall	Part Number
NW 10	0.50 (13)	0.065 (1.7)	100314300
NW 16	0.75 (19)	0.065 (1.7)	100314301
NW 25	1.00 (25)	0.065 (1.7)	100314303
NW 40	1.50 (38)	0.065 (1.7)	100314305
NW 50	2.00 (51)	0.065 (1.7)	100314306
NW 80	3.00 (76)	0.065 (1.7)	100764508
NW 100	4.00 (102)	0.065 (1.7)	100764510
NW 100	4.00 (102)	0.083 (2.1)	100764511

ISO-KF Bellows Section

in./(mm)

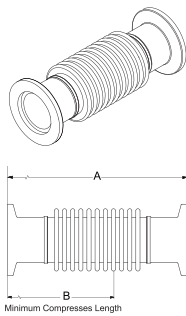

- Stainless Steel Type 321

Flange Size (ISO)	Static Bend Radius	Hose Wall	A	B	Spring Rate	Part Number
NW 16	1 1/8"	.006 (0.15)	3.94 (100)	3.07 (78)	56 lb/in	100314911G
NW 25	1 3/8"	.006 (0.15)	3.94 (100)	3.07 (78)	44 lb/in	100314913G
NW 40	2 1/2"	.006 (0.15)	3.94 (100)	2.93 (74)	32 lb/in	100314915G
NW 50	3 1/4"	.006 (0.15)	3.94 (100)	3.11 (79)	32 lb/in	100314916G

ISO-KF Thick Wall Metal Hose

in./(mm)

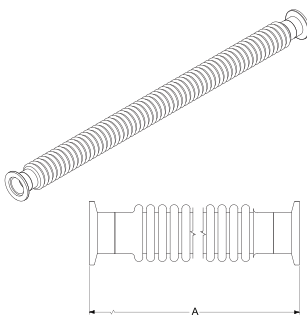

- Stainless Steel
- Unsheathed
- Buttwelded
- Special Lengths to Order
- Thick wall hose static bend radius is to point of permanent deformation

Flange Size (ISO)	Static Bend Radius	Hose Wall	A	Spring Rate	Part Number
NW 16	2 1/8"	.012 (0.30)	9.84 (250)	256 lb/in	100315901
NW 16	2 1/8"	.012 (0.30)	19.69 (500)	128 lb/in	100316001
NW 16	2 1/8"	.012 (0.30)	39.40 (1000)	64 lb/in	100316111
NW 25	2 7/8"	.012 (0.30)	9.84 (250)	224 lb/in	100315903
NW 25	2 7/8"	.012 (0.30)	19.69 (500)	112 lb/in	100316003
NW 25	2 7/8"	.012 (0.30)	39.40 (1000)	56 lb/in	100316113
NW 40	3 1/2"	.012 (0.30)	9.84 (250)	220 lb/in	100315905
NW 40	3 1/2"	.012 (0.30)	19.69 (500)	110 lb/in	100316005
NW 40	3 1/2"	.012 (0.30)	39.40 (1000)	55 lb/in	100316115
NW 50	5 1/4"	.012 (0.30)	9.84 (250)	220 lb/in	100315906
NW 50	5 1/4"	.012 (0.30)	19.69 (500)	110 lb/in	100316006
NW 50	5 1/4"	.012 (0.30)	39.40 (1000)	55 lb/in	100316116

ISO-KF Thin Wall Metal Hose

in./(mm)

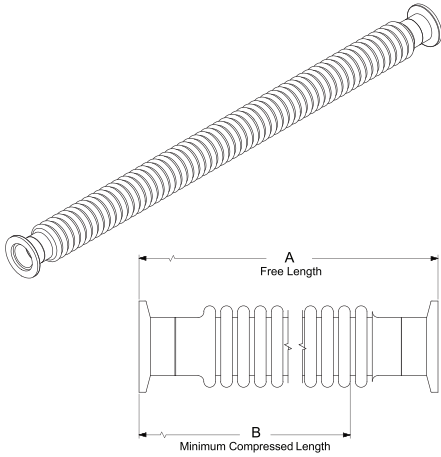

- Stainless Steel
- Unsheathed
- Buttwelded
- Special Lengths to Order

Flange Size (ISO)	Static Bend Radius	Hose Wall	A	B	Spring Rate	Part Number
NW 16	1 5/8"	.006 (0.15)	9.84 (250)	6.41 (163)	27 lb/in	100317411
NW 16	1 5/8"	.006 (0.15)	12.02 (305)	7.82 (199)	21 lb/in	100319805
NW 16	1 5/8"	.006 (0.15)	19.69 (500)	12.30 (313)	12 lb/in	100317421
NW 16	1 5/8"	.006 (0.15)	24.09 (612)	18.12 (460)	9 lb/in	100319808
NW 16	1 5/8"	.006 (0.15)	39.40 (1000)	24.10 (613)	5.8 lb/in	100317441
NW 25	1 3/8"	.006 (0.15)	9.84 (250)	6.41 (163)	16 lb/in	100317413
NW 25	1 3/8"	.006 (0.15)	11.99 (305)	7.82 (199)	14 lb/in	100319806
NW 25	1 3/8"	.006 (0.15)	19.69 (500)	12.30 (313)	7.3 lb/in	100317423
NW 25	1 3/8"	.006 (0.15)	24.00 (610)	18.12 (460)	6.5 lb/in	100319809
NW 25	1 3/8"	.006 (0.15)	39.40 (1000)	24.10 (613)	3.4 lb/in	100317443
NW 40	2 1/2"	.006 (0.15)	9.84 (250)	6.23 (158)	8.6 lb/in	100317415
NW 40	2 1/2"	.006 (0.15)	12.12 (308)	7.88 (200)	7 lb/in	100319807
NW 40	2 1/2"	.006 (0.15)	19.69 (500)	11.70 (297)	3.9 lb/in	100317425
NW 40	2 1/2"	.006 (0.15)	24.05 (611)	18.12 (460)	3 lb/in	100319810
NW 40	2 1/2"	.006 (0.15)	39.40 (1000)	22.50 (571)	1.9 lb/in	100317445
NW 50	3 1/4"	.006 (0.15)	9.84 (250)	7.05 (179)	13 lb/in	100317416
NW 50	3 1/4"	.006 (0.15)	11.93 (303)	8.64 (219)	12 lb/in	100319817
NW 50	3 1/4"	.006 (0.15)	19.69 (500)	13.50 (342)	5.9 lb/in	100317426
NW 50	3 1/4"	.006 (0.15)	24.08 (612)	18.12 (460)	5 lb/in	100319811
NW 50	3 1/4"	.006 (0.15)	39.40 (1000)	26.30 (667)	2.9 lb/in	100317446

ISO-KF Braided Metal Hose

in./(mm)

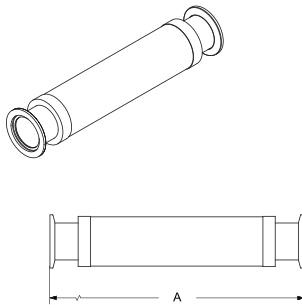

- Ideal for rough pumping lines
- Stainless Steel
- Flexible, yet resistant to contraction

Flange Size (ISO)	Static Bend Radius	A	Part Number
NW 16	2 1/2"	10.23 (259)	100313201
NW 16	2 1/2"	20.23 (514)	100313301
NW 16	2 1/2"	40.23 (1022)	100313401
NW 25	3"	10.27 (261)	100313203
NW 25	3"	20.27 (515)	100313303
NW 25	3"	40.27 (1023)	100313403
NW 40	5"	10.28 (261)	100313205
NW 40	5"	20.28 (515)	100313305
NW 40	5"	40.28 (1023)	100313405
NW 50	6"	10.53 (268)	100313206
NW 50	6"	20.53 (522)	100313306
NW 50	6"	40.53 (1030)	100313406

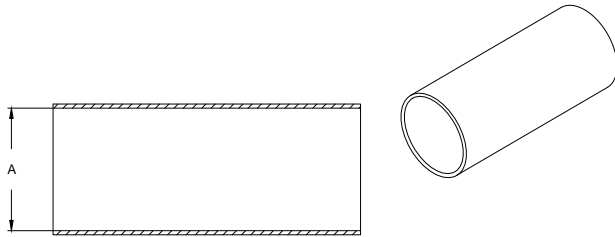

- Good for exhaust lines
- Wire molded in tube wall for reinforcement
- Larger OD PVC has limited flexibility in short lengths

PVC Hose in./(mm)

Flange Size (ISO)	A	Part Number
NW 10	0.50 (13)	100317500-100
NW 16	0.75 (19)	100317501-100
NW 25	1.00 (25)	100317503-100
NW 40	1.50 (38)	100317505-50
NW 50	2.00 (51)	100317506-50

PVC Hose Clamps in./(mm)

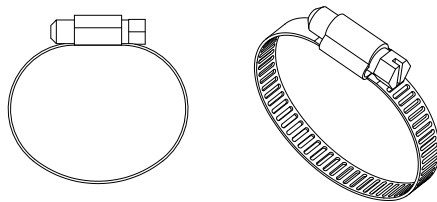

Flange Size (ISO)	A	Part Number
NW 10	1/2"	100000797
NW 16	3/4"	100000935
NW 25	1"	100000936
NW 40	1 1/2"	100000937
NW 50	2"	100000938

- Protects Flange Faces
- Plastic

Flange Protector Caps in./(mm)

Flange Size (ISO)	Part Number
NW 16	100310001
NW 25	100310003
NW 40	100310005
NW 50	100310006

10000797	PVC Hose Clamp, NW 10, 1/2"	100311801	Adapter, Hose , NW 16 to 5/8" or 3/4", Aluminum
10000935	PVC Hose Clamp, NW 16, 3/4"	100311803	Adapter, Hose , NW 25 to 3/4" or 7/8", Aluminum
10000936	PVC Hose Clamp, NW 25 1"	100311805	Adapter, Hose , NW 40 to 1 1/2" or 1 5/8", Aluminum
10000937	PVC Hose Clamp, NW 40 1 1/2"	100311806	Adapter, Hose , NW 50 to 1 1/2" or 1 5/8", Aluminum
10000938	PVC Hose Clamp, NW 50 2"	100311811	Adapter, Hose , NW 16 to 1/2" or 5/8", Aluminum
100001380	Seal, ASA O-ring, 2-231, 1 1/2", Viton	100312000	Adapter Pipe, NW 10 to 1/8" NPT, female, Aluminum
100006098	Seal, ASA O-ring, 2-237, 2", Viton	100312001	Adapter Pipe, NW 16 to 1/8" NPT, female, Aluminum
100006099	Seal, ASA O-ring, 2-247, 3", Viton	100312003	Adapter Pipe, NW 25 to 1/8" NPT, female, Aluminum
100310001	Flange Protector Caps, NW 16, Plastic	100312005	Adapter Pipe, NW 40 to 1/8" NPT, female, Aluminum
100310003	Flange Protector Caps, NW 25, Plastic	100312006	Adapter Pipe, NW 50 to 1/8" NPT, female, Aluminum
100310005	Flange Protector Caps, NW 40, Plastic	100312100	Adapter Pipe, NW 10 to 1/8" NPT, female, SS
100310006	Flange Protector Caps, NW 50, Plastic	100312101	Adapter Pipe, NW 16 to 1/8" NPT, female, SS
100310101	Flange, Short Weld Stub, NW 16, Aluminum	100312103	Adapter Pipe, NW 25 to 1/8" NPT, female, SS
100310103	Flange, Short Weld Stub, NW 25, Aluminum	100312105	Adapter Pipe, NW 40 to 1/8" NPT, female, SS
100310105	Flange, Short Weld Stub, NW 40, Aluminum	100312106	Adapter Pipe, NW 50 to 1/8" NPT, female, SS
100310106	Flange, Short Weld Stub, NW 50, Aluminum	100312200	Adapter Pipe, NW 10 to 1/4" NPT-F, Aluminum
100310111	Flange, Short Weld Stub, NW 16, Aluminum	100312201	Adapter Pipe, NW 16 to 1/4" NPT-F, Aluminum
100310201	Flange, Long Weld Stub, NW 16, Aluminum	100312203	Adapter Pipe, NW 25 to 1/4" NPT-F, Aluminum
100310203	Flange, Long Weld Stub, NW 25, Aluminum	100312205	Adapter Pipe, NW 40 to 1/4" NPT-F, Aluminum
100310205	Flange, Long Weld Stub, NW 40, Aluminum	100312206	Adapter Pipe, NW 50 to 1/4" NPT-F, Aluminum
100310206	Flange, Long Weld Stub, NW 50, Aluminum	100312300	Adapter Pipe, NW 10 to 1/4" NPT-F, SS
100310211	Flange, Long Weld Stub, NW 16, Aluminum	100312301	Adapter Pipe, NW 16 to 1/4" NPT-F, SS
100310300	Flange, Short Weld Stub, NW 10, 304 SS	100312303	Adapter Pipe, NW 25 to 1/4" NPT-F, SS
100310301	Flange, Short Weld Stub, NW 16, 304 SS	100312305	Adapter Pipe, NW 40 to 1/4" NPT-F, SS
100310303	Flange, Short Weld Stub, NW 25, 304 SS	100312306	Adapter Pipe, NW 50 to 1/4" NPT-F, SS
100310305	Flange, Short Weld Stub, NW 40, 304 SS	100312500	Centering Ring Assy, NW 10, Alum./Buna-N O-ring
100310306	Flange, Short Weld Stub, NW 50, 304 SS	100312501	Centering Ring Assy, NW 16, Alum./Buna-N O-ring
100310311	Flange, Short Weld Stub, NW 16, 304 SS	100312503	Centering Ring Assy, NW 25, Alum./Buna-N O-ring
100311100	Flange, Unbored, NW 10, Aluminum	100312505	Centering Ring Assy, NW 40, Alum./Buna-N O-ring
100311101	Flange, Unbored, NW 16, Aluminum	100312506	Centering Ring Assy, NW 50, Alum./Buna-N O-ring
100311103	Flange, Unbored, NW 25, Aluminum	100312600	Centering Ring Assy, NW 10, Alum./Viton O-ring
100311105	Flange, Unbored, NW 40, Aluminum	100312601	Centering Ring Assy, NW 16, Alum./Viton O-ring
100311106	Flange, Unbored, NW 50, Aluminum	100312603	Centering Ring Assy, NW 25, Alum./Viton O-ring
100311300	Flange, Unbored, NW 10, 304 Stainless Steel	100312605	Centering Ring Assy, NW 40, Alum./Viton O-ring
100311301	Flange, Unbored, NW 16, 304 Stainless Steel	100312606	Centering Ring Assy, NW 50, Alum./Viton O-ring
100311303	Flange, Unbored, NW 25, 304 Stainless Steel	100312700	Centering Ring Assy, NW 10, SS/Viton O-ring
100311305	Flange, Unbored, NW 40, 304 Stainless Steel	100312701	Centering Ring Assy, NW 16, SS/Viton O-ring
100311306	Flange, Unbored, NW 50, 304 Stainless Steel	100312703	Centering Ring Assy, NW 25, SS/Viton O-ring
100311600	Flange, Blank-Off, NW 10, Aluminum	100312705	Centering Ring Assy, NW 40, SS/Viton O-ring
100311601	Flange, Blank-Off, NW 16, Aluminum	100312706	Centering Ring Assy, NW 50, SS/Viton O-ring
100311603	Flange, Blank-Off, NW 25, Aluminum	100312800	Centering Ring Assy, NW 10, SS/Buna-N O-ring
100311605	Flange, Blank-Off, NW 40, Aluminum	100312801	Centering Ring Assy, NW 16, SS/Buna-N O-ring
100311606	Flange, Blank-Off, NW 50, Aluminum	100312803	Centering Ring Assy, NW 25, SS/Buna-N O-ring
100311700	Flange, Blank-Off, NW 10, 304 Stainless Steel	100312805	Centering Ring Assy, NW 40, SS/Buna-N O-ring
100311701	Flange, Blank-Off, NW 16, 304 Stainless Steel	100312806	Centering Ring Assy, NW 50, SS/Buna-N O-ring
100311703	Flange, Blank-Off, NW 25, 304 Stainless Steel	100312901	Wing Nut Clamp, NW 16, fits 16/10, Aluminum
100311705	Flange, Blank-Off, NW 40, 304 Stainless Steel	100312903	Wing Nut Clamp, NW 25, fits 25/20, Aluminum
100311706	Flange, Blank-Off, NW 50, 304 Stainless Steel	100312905	Wing Nut Clamp, NW 40, fits 40/32, Aluminum
		100312906	Wing Nut Clamp, NW 50, fits 50, Aluminum

100313201	Braided Metal Hose, 10", NW 16, Stainless Steel	100314801	Cross, NW 16, 304 Stainless Steel
100313203	Braided Metal Hose, 10", NW 25, Stainless Steel	100314803	Cross, NW 25, 304 Stainless Steel
100313205	Braided Metal Hose, 10", NW 40, Stainless Steel	100314805	Cross, NW 40, 304 Stainless Steel
100313206	Braided Metal Hose, 10", NW 50, Stainless Steel	100314806	Cross, NW 50, 304 Stainless Steel
100313301	Braided Metal Hose, 20", NW 16, Stainless Steel		
100313303	Braided Metal Hose, 20", NW 25, Stainless Steel	100314911G	Bellows, NW 16, Stainless Steel
100313305	Braided Metal Hose, 20", NW 40, Stainless Steel	100314913G	Bellows, NW 25, Stainless Steel
100313306	Braided Metal Hose, 20", NW 50, Stainless Steel	100314915G	Bellows, NW 40, Stainless Steel
100313401	Braided Metal Hose, 40", NW 16, Stainless Steel	100314916G	Bellows, NW 50, Stainless Steel
100313403	Braided Metal Hose, 40", NW 25, Stainless Steel		
100313405	Braided Metal Hose, 40", NW 40, Stainless Steel		
100313406	Braided Metal Hose, 40", NW 50, Stainless Steel		
		100315101	Straight Section, NW 16, 304 Stainless Steel
		100315103	Straight Section, NW 25, 304 Stainless Steel
		100315105	Straight Section, NW 40, 304 Stainless Steel
100313511	Conical Reducer, NW 16 to NW 25, Aluminum	100315106	Straight Section, NW 50, 304 Stainless Steel
100313512	Conical Reducer, NW 16 to NW 40, Aluminum	100315111	Straight Section, NW 16, 304 Stainless Steel
100313513	Conical Reducer, NW 16 to NW 50, Aluminum	100315113	Straight Section, NW 25, 304 Stainless Steel
100313514	Conical Reducer, NW 25 to NW 40, Aluminum	100315115	Straight Section, NW 40, 304 Stainless Steel
100313515	Conical Reducer, NW 25 to NW 50, Aluminum	100315116	Straight Section, NW 50, 304 Stainless Steel
100313516	Conical Reducer, NW 40 to NW 50, Aluminum		
		100315601	Adapter, ISO-KF to CF, NW 16 to 1-1/3" CF, SS
100313711	Conical Reducer, NW 16 to NW 25, 304 SS	100315603	Adapter, ISO-KF to CF, NW 25 to 2-3/4" CF, SS
100313712	Conical Reducer, NW 16 to NW 40, 304 SS	100315605	Adapter, ISO-KF to CF, NW 40 to 2-3/4" CF, SS
100313713	Conical Reducer, NW 16 to NW 50, 304 SS	100315606	Adapter, ISO-KF to CF, NW 50 to 4-1/2" CF, SS
100313714	Conical Reducer, NW 25 to NW 40, 304 SS	100315611	Adapter, ISO-KF to CF, NW 16 to 2-3/4" CF, SS
100313715	Conical Reducer, NW 25 to NW 50, 304 SS		
100313716	Conical Reducer, NW 40 to NW 50, 304 SS		
		100315700	Flange, Long Weld Stub, NW 10, 304 SS
100313900	O-Ring, standard size 2-312, NW 10, Buna-N	100315701	Flange, Long Weld Stub, NW 16, 304 SS
100313901	O-Ring, standard size 2-314, NW 16, Buna-N	100315703	Flange, Long Weld Stub, NW 25, 304 SS
100313903	O-Ring, standard size 2-320, NW 25, Buna-N	100315705	Flange, Long Weld Stub, NW 40, 304 SS
100313905	O-Ring, standard size 2-326, NW 40, Buna-N	100315706	Flange, Long Weld Stub, NW 50, 304 SS
100313906	O-Ring, standard size 2-330, NW 50, Buna-N	100315711	Flange, Long Weld Stub, NW 16, 304 SS
100314000	O-Ring, standard size 2-312, NW 10, Viton	100315801	Seal Assembly, NW 16 to NW 10, Aluminum/Buna
100314001	O-Ring, standard size 2-314, NW 16, Viton	100315803	Seal Assembly, NW 25 to NW 20, Aluminum/Buna
100314003	O-Ring, standard size 2-320, NW 25, Viton	100315805	Seal Assembly, NW 40 to NW 32, Aluminum/Buna
100314005	O-Ring, standard size 2-326, NW 40, Viton		
100314006	O-Ring, standard size 2-330, NW 50, Viton	100315811	Seal Assembly, NW 16 to NW 10, Aluminum/Viton O-ring
		100315813	Seal Assembly, NW 25 to NW 20, Aluminum/Viton
		100315815	Seal Assembly, NW 40 to NW 32, Aluminum/Viton
100314300	Tube (price per 10 foot), NW 10, 0.50" O.D., SS		
100314301	Tube (price per 10 foot), NW 16, 0.75" O.D., SS	100315821	Seal Assembly, NW 16 to NW 10, SS/Viton
100314303	Tube (price per 10 foot), NW 25, 1.00" O.D., SS	100315823	Seal Assembly, NW 25 to NW 20, SS/Viton
100314305	Tube (price per 10 foot), NW 40, 1.50" O.D., SS	100315825	Seal Assembly, NW 40 to NW 32, SS/Viton
100314306	Tube (price per 10 foot), NW 50, 2.00" O.D., SS		
		100315901	Metal Hose, Thick Wall, 10", NW 16, SS
100314401	90° Elbow, Smooth Radius, NW 16, 304 SS	100315903	Metal Hose, Thick Wall, 10", NW 25, SS
100314403	90° Elbow, Smooth Radius, NW 25, 304 SS	100315905	Metal Hose, Thick Wall, 10", NW 40, SS
100314415	90° Elbow, Long Radius, NW 40, 304 SS	100315906	Metal Hose, Thick Wall, 10", NW 50, SS
100314416	90° Elbow, Long Radius, NW 50, 304 SS	100316001	Metal Hose, Thick Wall, 20", NW 16, SS
100314505	90° Elbow, Smooth Radius, NW 40, 304 SS	100316003	Metal Hose, Thick Wall, 20", NW 25, SS
100314506	90° Elbow, Smooth Radius, NW 50, 304 SS	100316005	Metal Hose, Thick Wall, 20", NW 40, SS
		100316006	Metal Hose, Thick Wall, 20", NW 50, SS
100314601	Tee, NW 16, 304 Stainless Steel	100316111	Metal Hose, Thick Wall, 40", NW 16, SS
100314603	Tee, NW 25, 304 Stainless Steel	100316113	Metal Hose, Thick Wall, 40", NW 25, SS
100314605	Tee, NW 40, 304 Stainless Steel	100316115	Metal Hose, Thick Wall, 40", NW 40, SS
100314606	Tee, NW 50, 304 Stainless Steel	100316116	Metal Hose, Thick Wall, 40", NW 50, SS



100316301	Overpressure Ring, NW 16, 304 SS/Silicone	100317300	Centering Ring Assy, NW 10, SS/Silicone O-ring
100316303	Overpressure Ring, NW 25, 304 SS/Silicone	100317301	Centering Ring Assy, NW 16, SS/Silicone O-ring
100316305	Overpressure Ring, NW 40, 304 SS/Silicone	100317303	Centering Ring Assy, NW 25, SS/Silicone O-ring
100316306	Overpressure Ring, NW 50, 304 SS/Silicone	100317305	Centering Ring Assy, NW 40, SS/Silicone O-ring
		100317306	Centering Ring Assy, NW 50, SS/Silicone O-ring
100316400	Adapter, NW 10 to 1/2" PVC Tubing, 304 SS		
100316401	Adapter, NW 16 to 3/4" PVC Tubing, 304 SS	100317310	O-Ring, standard size 2-312, NW 10, Silicone 604
100316403	Adapter, NW 25 to 1" PVC Tubing, 304 SS	100317311	O-Ring, standard size 2-314, NW 16, Silicone 604
100316405	Adapter, NW 40 to 1 1/2" PVC Tubing, 304 SS	100317313	O-Ring, standard size 2-320, NW 25, Silicone 604
100316406	Adapter, NW 50 to 2" PVC Tubing, 304 SS	100317315	O-Ring, standard size 2-326, NW 40, Silicone 604
100316411	Adapter, NW 16 to 1/2" PVC Tubing, 304 SS	100317316	O-Ring, standard size 2-330, NW 50, Silicone 604
100316705	Adapter, NW 40 to 2" ASA, w/out groove, 304 SS	100317411	Metal Hose, Thin Wall, 10", NW 16, SS
100316706	Adapter, NW 50 to 2" ASA, w/out groove, 304 SS	100317413	Metal Hose, Thin Wall, 10", NW 25, SS
100316715	Adapter, NW 40 to 3" ASA, w/out groove, 304 SS	100317415	Metal Hose, Thin Wall, 10", NW 40, SS
100316716	Adapter, NW 50 to 3" ASA, w/out groove, 304 SS	100317416	Metal Hose, Thin Wall, 10", NW 50, SS
		100317421	Metal Hose, Thin Wall, 20", NW 16, SS
100316725	Adapter, NW 40 to 2" ASA with groove, 304 SS	100317423	Metal Hose, Thin Wall, 20", NW 25, SS
100316726	Adapter, NW 50 to 2" ASA with groove, 304 SS	100317425	Metal Hose, Thin Wall, 20", NW 40, SS
100316735	Adapter, NW 40 to 3" ASA with groove, 304 SS	100317426	Metal Hose, Thin Wall, 20", NW 50, SS
100316736	Adapter, NW 50 to 3" ASA with groove, 304 SS	100317441	Metal Hose, Thin Wall, 40", NW 16, SS
		100317443	Metal Hose, Thin Wall, 40", NW 25, SS
100316755	Adapter, NW 40 to 1.5" ASA, w/out groove, 304 SS	100317445	Metal Hose, Thin Wall, 40", NW 40, SS
100316756	Adapter, NW 50 to 1.5" ASA, w/out groove, 304 SS	100317446	Metal Hose, Thin Wall, 40", NW 50, SS
100316775	Adapter, NW 40 to 1.5" ASA with groove, 304 SS	100317500-100	PVC Hose (price per 100 foot), NW 10, PVC
100316776	Adapter, NW 50 to 1.5" ASA with groove, 304 SS	100317501-100	PVC Hose (price per 100 foot), NW 16, PVC
		100317503-100	PVC Hose (price per 100 foot), NW 25, PVC
100316801	Adapter, NW 16 to 1/8" NPT-M, 304 SS	100317505-50	PVC Hose (price per 50 foot), NW 40, PVC
100316803	Adapter, NW 25 to 1/8" NPT-M, 304 SS	100317506-50	PVC Hose (price per 50 foot), NW 50, PVC
100316805	Adapter, NW 40 to 1/4" NPT-M, 304 SS		
100316806	Adapter, NW 50 to 1/4" NPT-M, 304 SS	100318301	Weld Socket Flange, NW 16, 304 SS
100316811	Adapter, NW 16 to 1/4" NPT-M, 304 SS	100318303	Weld Socket Flange, NW 25, 304 SS
100316813	Adapter, NW 25 to 1/4" NPT-M, 304 SS	100318305	Weld Socket Flange, NW 40, 304 SS
100316815	Adapter, NW 40 to 1/2" NPT-M, 304 SS	100318306	Weld Socket Flange, NW 50, 304 SS
100316816	Adapter, NW 50 to 1/2" NPT-M, 304 SS	100318311	Weld Socket Flange, NW 16, 304 SS
100316823	Adapter, NW 25 to 1/2" NPT-M, 304 SS	100318321	Weld Socket Flange, NW 16, 304 SS
100316825	Adapter, NW 40 to 3/4" NPT-M, 304 SS		
100316826	Adapter, NW 50 to 3/4" NPT-M, 304 SS	100318403	Reducing Tee, NW 25 to NW 16, 304 SS
100316833	Adapter, NW 25 to 3/4" NPT-M, 304 SS	100318405	Reducing Tee, NW 40 to NW 16, 304 SS
100316835	Adapter, NW 40 to 1" NPT-M, 304 SS	100318406	Reducing Tee, NW 50 to NW 16, 304 SS
100316836	Adapter, NW 50 to 1" NPT-M, 304 SS		
100316844	Adapter, NW 40 to 1.25" NPT-M, 304 SS	100318601	Seal Assembly w/Screen, NW 16, SS/Viton O-ring
100316845	Adapter, NW 40 to 1.5" NPT-M, 304 SS	100318603	Seal Assembly w/Screen, NW 25, SS/Viton O-ring
100316846	Adapter, NW 50 to 2" NPT-M, 304 SS	100318605	Seal Assembly w/Screen, NW 40, SS/Viton O-ring
		100318606	Seal Assembly w/Screen, NW 50, SS/Viton O-ring
100316903	Adapter Tubing, NW 25 to 1/2", SS, Viton O-Ring	100318701	45° Elbow, Smooth Radius, NW 16, 304 SS
100316905	Adapter Tubing, NW 40 to 1/2", SS, Viton O-Ring	100318703	45° Elbow, Smooth Radius, NW 25, 304 SS
100316906	Adapter Tubing, NW 50 to 1 1/2", SS, Viton O-Ring	100318705	45° Elbow, Smooth Radius, NW 40, 304 SS
100316910	Adapter Tubing, NW 10 to 1/2", SS, Viton O-Ring	100318706	45° Elbow, Smooth Radius, NW 50, 304 SS
100316911	Adapter Tubing, NW 16 to 1/4", SS, Viton O-Ring		
100316913	Adapter Tubing, NW 25 to 3/4", SS, Viton O-Ring	100318801	Toggle Clamp, NW 16, fits 16/10, Aluminum
100316915	Adapter Tubing, NW 40 to 3/4", SS, Viton O-Ring	100318803	Toggle Clamp, NW 25, fits 25/20, Aluminum
100316916	Adapter Tubing, NW 50 to 2", SS, Viton O-Ring	100318805	Toggle Clamp, NW 40, fits 40/32, Aluminum
100316921	Adapter Tubing, NW 16 to 1/2", SS, Viton O-Ring	100318806	Toggle Clamp, NW 50, fits 50, Aluminum
100316923	Adapter Tubing, NW 25 to 1", SS, Viton O-Ring		
100316925	Adapter Tubing, NW 40 to 1", SS, Viton O-Ring	100318801-L	Toggle Clamp w/ Lanyard, NW 16, 16/10, Aluminum
100316926	Adapter Tubing, NW 50 to 3/4", SS, Viton O-Ring	100318803-L	Toggle Clamp w/ Lanyard, NW 25, 25/20, Aluminum
100316931	Adapter Tubing, NW 16 to 3/4", SS, Viton O-Ring	100318805-L	Toggle Clamp w/ Lanyard, NW 40, 40/32, Aluminum
100316935	Adapter Tubing, NW 40 to 1 1/2", SS, Viton O-Ring	100318806-L	Toggle Clamp w/ Lanyard, NW 50, 50, Aluminum
100316936	Adapter Tubing, NW 50 to 1", SS, Viton O-Ring		
100316945	Adapter Tubing, NW 40 to 1 1/8", SS, Viton O-Ring		
100316946	Adapter Tubing, NW 50 to 1 1/8", SS, Viton O-Ring		

100318901	Bulkhead Clamp, 6 Bolts, NW 16, Aluminum	100319731	Flange, Blank with Bore, NW 16, 304 SS
100318903	Bulkhead Clamp, 6 Bolts, NW 25, Aluminum	100319733	Flange, Blank with Bore, NW 25, 304 SS
100318905	Bulkhead Clamp, 6 Bolts, NW 40, Aluminum	100319735	Flange, Blank with Bore, NW 40, 304 SS
100318906	Bulkhead Clamp, 8 Bolts, NW 50, Aluminum	100319736	Flange, Blank with Bore, NW 50, 304 SS
100319005	Bonded Viewport, NW 40, SS, Borosilicate Glass	100319743	Flange, Blank with Bore, NW 25, 304 SS
100319006	Bonded Viewport, NW 50, SS, Borosilicate Glass	100319745	Flange, Blank with Bore, NW 40, 304 SS
100319111	Adapter, VCR-M, NW 16 to 4 VCR, SS	100319746	Flange, Blank with Bore, NW 50, 304 SS
100319113	Adapter, VCR-M, NW 25 to 4 VCR, SS	100319755	Flange, Blank with Bore, NW 40, 304 SS
100319115	Adapter, VCR-M, NW 40 to 4 VCR, SS	100319756	Flange, Blank with Bore, NW 50, 304 SS
100319116	Adapter, VCR-M, NW 50 to 4 VCR, SS	100319766	Flange, Blank with Bore, NW 50, 304 SS
100319121	Adapter, VCR-M, NW 16 to 8 VCR, SS	100319801	Flange, Blank with Bore, NW 80, 304 SS
100319123	Adapter, VCR-M, NW 25 to 8 VCR, SS	100319802	Flange, Blank-Off, NW 80, 304 SS
100319125	Adapter, VCR-M, NW 40 to 8 VCR, SS	100319803	Flange, Blank with Bore, NW 100, 304 SS
100319126	Adapter, VCR-M, NW 50 to 8 VCR, SS	100319804	Flange, Blank-Off, NW 100, 304 SS
100319133	Adapter, VCR-M, NW 25 to 12 VCR, SS	100319805	Metal Hose, Thin Wall, 12", NW 16, SS
100319135	Adapter, VCR-M, NW 40 to 12 VCR, SS	100319806	Metal Hose, Thin Wall, 12", NW 25, SS
100319136	Adapter, VCR-M, NW 50 to 12 VCR, SS	100319807	Metal Hose, Thin Wall, 12", NW 40, SS
100319211	Adapter, VCR-F, NW 16 to 4 VCR, SS	100319808	Metal Hose, Thin Wall, 24", NW 16, SS
100319213	Adapter, VCR-F, NW 25 to 4 VCR, SS	100319809	Metal Hose, Thin Wall, 24", NW 25, SS
100319215	Adapter, VCR-F, NW 40 to 4 VCR, SS	100319810	Metal Hose, Thin Wall, 24", NW 40, SS
100319216	Adapter, VCR-F, NW 50 to 4 VCR, SS	100319811	Metal Hose, Thin Wall, 24", NW 50, SS
100319221	Adapter, VCR-F, NW 16 to 8 VCR, SS	100319817	Metal Hose, Thin Wall, 12", NW 50, SS
100319223	Adapter, VCR-F, NW 25 to 8 VCR, SS	100319812	Adapter, NW 25 to 2 1/8" CF, 304 SS
100319225	Adapter, VCR-F, NW 40 to 8 VCR, SS	100319813	Adapter, NW 50 to 2 3/4" CF, 304 SS
100319226	Adapter, VCR-F, NW 50 to 8 VCR, SS	100319814	Reducing Tee, NW 50 to NW 40, 304 SS
100319233	Adapter, VCR-F, NW 25 to 12 VCR, SS	100319815	Reducing Tee, NW 50 to NW 25, 304 SS
100319235	Adapter, VCR-F, NW 40 to 12 VCR, SS	100319816	Reducing Tee, NW 40 to NW 25, 304 SS
100319236	Adapter, VCR-F, NW 50 to 12 VCR, SS	100760508	Seal Assembly, NW 80, SS/Viton O-ring
100319301	Adapter Tee, NW 16 to 1/8" NPT-F, Aluminum	100760510	Seal Assembly, NW 100, SS/Viton O-ring
100319303	Adapter Tee, NW 25 to 1/8" NPT-F, Aluminum	100760608	Seal Assembly, NW 80, Aluminum/Viton O-ring
100319305	Adapter Tee, NW 40 to 1/8" NPT-F, Aluminum	100760610	Seal Assembly, NW 100, Aluminum/Viton O-ring
100319306	Adapter Tee, NW 50 to 1/8" NPT-F, Aluminum	100760708	Seal Assembly, NW 80, Aluminum/Buna-N O-ring
100319401	Adapter Tee, NW 16 to 1/8" NPT-F, 304 SS	100760710	Seal Assembly, NW 100, Aluminum/Buna-N O-ring
100319403	Adapter Tee, NW 25 to 1/8" NPT-F, 304 SS	100761908	O-Ring, standard size 2-340, NW 80, Buna-N
100319405	Adapter Tee, NW 40 to 1/8" NPT-F, 304 SS	100761910	O-Ring, standard size 2-346, NW 100, Buna-N
100319406	Adapter Tee, NW 50 to 1/8" NPT-F, 304 SS	100762008	O-Ring, standard size 2-340, NW 80, Viton
100319501	Adapter Tee, NW 16 to 1/4" NPT-F, Aluminum	100762010	O-Ring, standard size 2-346, NW 100, Viton
100319503	Adapter Tee, NW 25 to 1/4" NPT-F, Aluminum	100762606	Step Adapter, NW 63 to NW 40, SS
100319505	Adapter Tee, NW 40 to 1/4" NPT-F, Aluminum	100762608	Step Adapter, NW 80 to NW 50, SS
100319506	Adapter Tee, NW 50 to 1/4" NPT-F, Aluminum	100762616	Step Adapter, NW 80 to NW 40, SS
100319601	Adapter Tee, NW 16 to 1/4" NPT-F, 304 SS	100762617	Step Adapter, NW 63 to NW 50, SS
100319603	Adapter Tee, NW 25 to 1/4" NPT-F, 304 SS	100762618	Step Adapter, NW 100 to NW 50, SS
100319605	Adapter Tee, NW 40 to 1/4" NPT-F, 304 SS	100762620	Step Adapter, NW 100 to NW 40, SS
100319606	Adapter Tee, NW 50 to 1/4" NPT-F, 304 SS	100764508	Tube (price per 10 foot), NW 80, 3.00" O.D., SS
100319700	Flange, Blank with Bore, NW 10, 304 SS	100764510	Tube (price per 10 foot), NW 100, 4.00" O.D., SS
100319701	Flange, Blank with Bore, NW 16, 304 SS	100764511	Tube (price per 10 foot), NW 100, 4.00" O.D., SS
100319703	Flange, Blank with Bore, NW 25, 304 SS	100765006	Conical Adapter, NW 63 to NW 40, SS
100319705	Flange, Blank with Bore, NW 40, 304 SS	100765008	Conical Adapter, NW 80 to NW 50, SS
100319706	Flange, Blank with Bore, NW 50, 304 SS	100765016	Conical Adapter, NW 80 to NW 40, SS
100319710	Flange, Blank with Bore, NW 10, 304 SS	100765017	Conical Adapter, NW 63 to NW 50, SS
100319711	Flange, Blank with Bore, NW 16, 304 SS	100765018	Conical Adapter, NW 100 to NW 50, SS
100319713	Flange, Blank with Bore, NW 25, 304 SS	100936523	Overpressure Seal Assy, NW 50, SS/Viton
100319715	Flange, Blank with Bore, NW 40, 304 SS	100936524	Overpressure Seal Assy, NW 40, SS/Viton
100319716	Flange, Blank with Bore, NW 50, 304 SS	100936525	Overpressure Seal Assy, NW 25, SS/Viton
100319720	Flange, Blank with Bore, NW 10, 304 SS	100993460	Chain Clamp, NW 80, Aluminum
100319721	Flange, Blank with Bore, NW 16, 304 SS	100994717	Chain Clamp, NW 100, Aluminum
100319723	Flange, Blank with Bore, NW 25, 304 SS		
100319725	Flange, Blank with Bore, NW 40, 304 SS		
100319726	Flange, Blank with Bore, NW 50, 304 SS		